

CLIP IT. COUNT IT.

Every Box Tops clip is worth 10¢. You can help by filling in this collection sheet with Box Tops from hundreds of products you know and use every day. 50 Box Tops = \$5 for your kid's school. Thanks for your help!

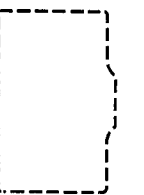

1 Clip Box Tops and check expiration date

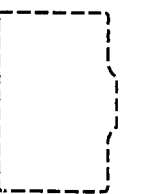
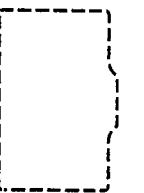
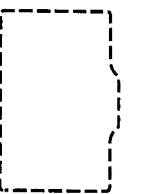
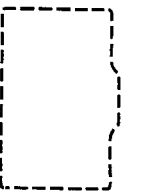
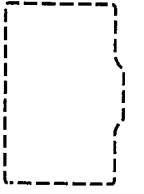
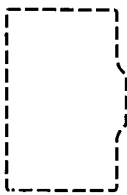
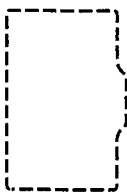
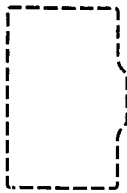
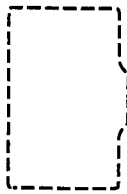
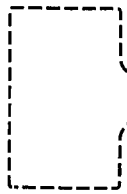

2 Tape or glue Box Tops on sheet until filled

3 Send completed sheet to your school Coordinator

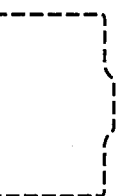
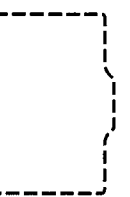
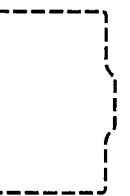
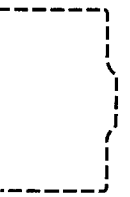
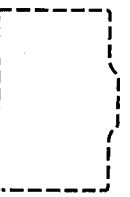
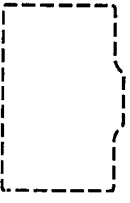
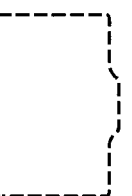
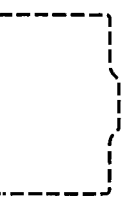
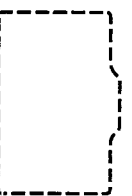
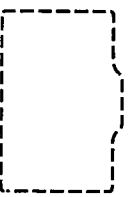
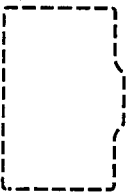
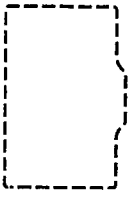
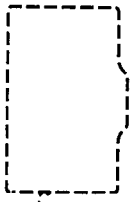
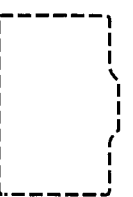
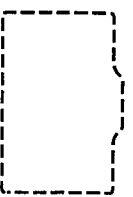
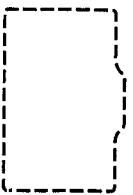
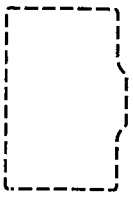
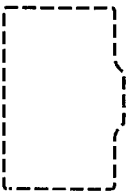
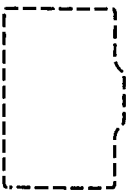
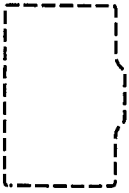
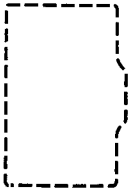



BE FIRST DAY READY

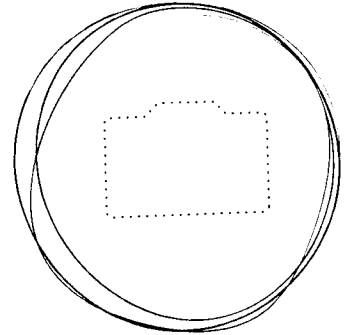
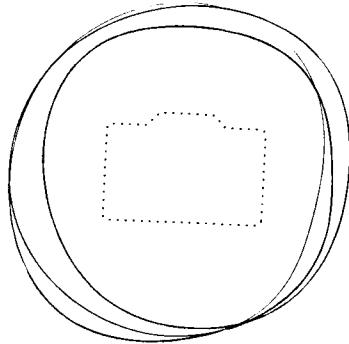
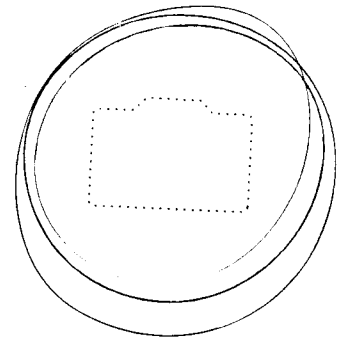
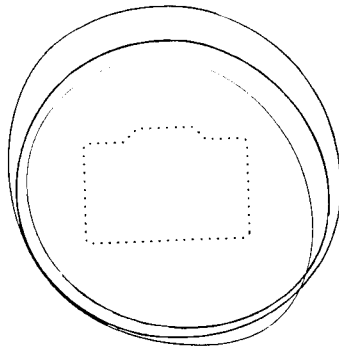

Go back to school with Box Tops and get a head start on earning for our school!
Tape or paste your clipped Box Tops to this sheet and turn it into school when all the spaces are filled. Bonus Box Tops certificates must be turned in separately.

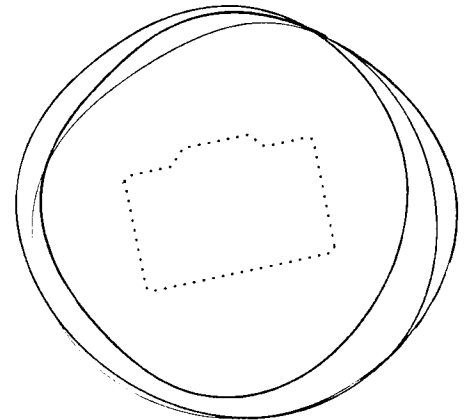
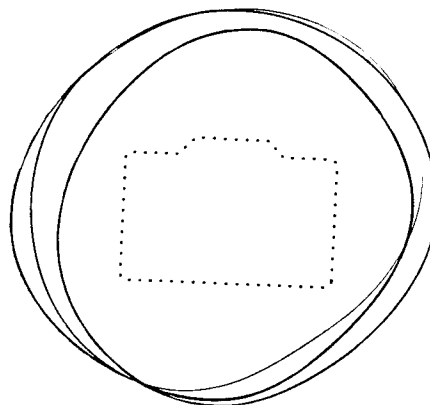
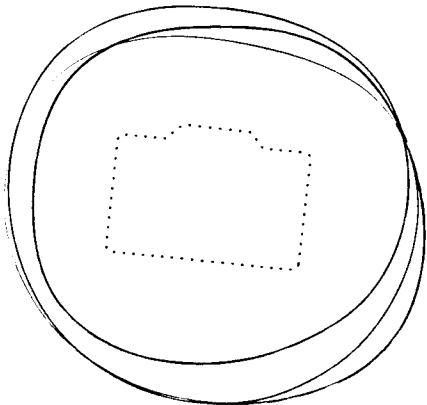
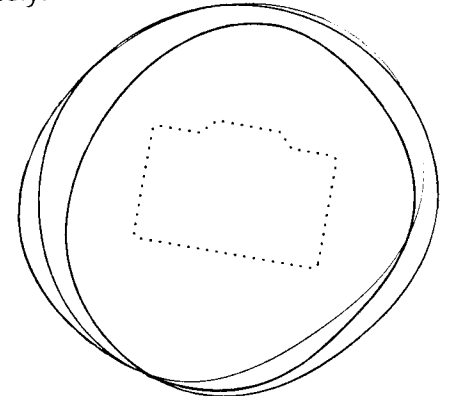
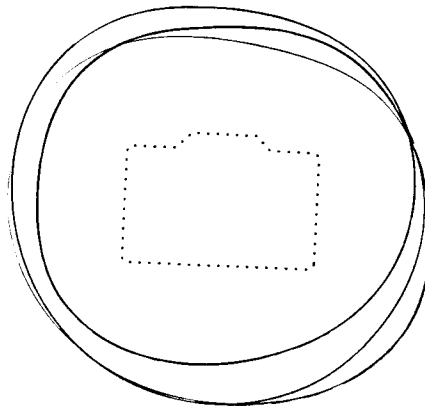
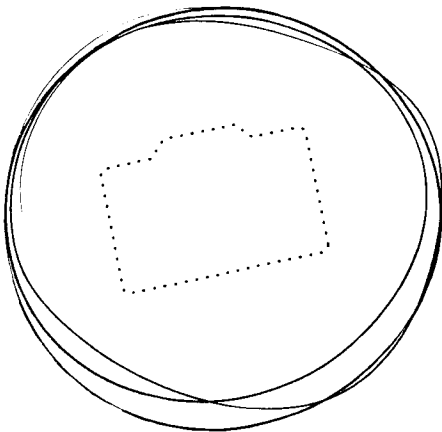

Thank you for helping! Box Tops are each worth 10¢ for our school.
To learn more about Box Tops for Education, go to BTFE.com.